

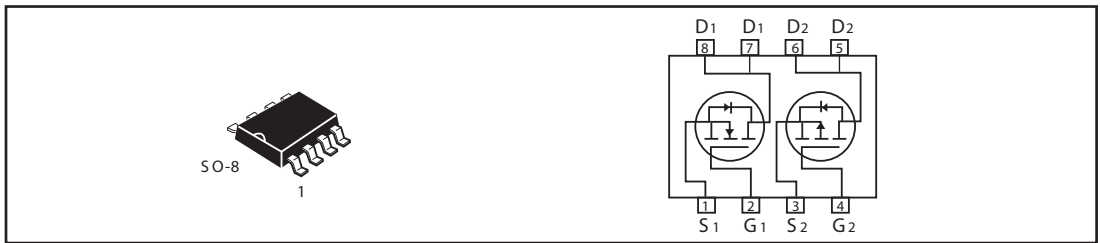

Dual Enhancement Mode Field Effect Transistor (N and P Channel)

PRODUCT SUMMARY (N-Channel)		
V _{DSS}	I _D	R _{DS(ON)} (mΩ) Max
30V	5.5A	40@ V _{GS} = 10V
		50@ V _{GS} = 4.5V

PRODUCT SUMMARY (P-Channel)		
V _{DSS}	I _D	R _{DS(ON)} (mΩ) Max
-30V	-4.5A	55@ V _{GS} = -10V
		85@ V _{GS} = -4.5V



ABSOLUTE MAXIMUM RATINGS (T_A=25°C unless otherwise noted)

Parameter	Symbol	N-Channel	P-Channel	Unit
Drain-Source Voltage	V _{DS}	30	-30	V
Gate-Source Voltage	V _{GS}	±20	±20	V
Drain Current-Continuous ^a @ T _J =125°C -Pulsed ^b	I _D	5.5	-4.5	A
	I _{DM}	23	-18	A
Drain-Source Diode Forward Current ^a	I _S	1.7	-1.7	A
Maximum Power Dissipation ^a	P _D	2.0		W
Operating Junction and Storage Temperature Range	T _J , T _{STG}	-55 to 150		°C

THERMAL CHARACTERISTICS

Thermal Resistance, Junction-to-Ambient ^a	R _{θJA}	62.5	°C/W
--	------------------	------	------

STM4532

N-Channel ELECTRICAL CHARACTERISTICS (T_A=25°C unless otherwise noted)

Parameter	Symbol	Condition	Min	Typ ^c	Max	Unit
OFF CHARACTERISTICS						
Drain-Source Breakdown Voltage	BV _{DSS}	V _{GS} =0V, I _D =250μA	30			V
Zero Gate Voltage Drain Current	I _{DSS}	V _{DS} =24V, V _{GS} =0V			1	μA
Gate-Body Leakage	I _{GSS}	V _{GS} = ± 20V, V _{DS} =0V			±100	nA
ON CHARACTERISTICS^b						
Gate Threshold Voltage	V _{GS(th)}	V _{DS} =V _{GS} , I _D = 250μA	0.8		1.8	V
Drain-Source On-State Resistance	R _{DS(ON)}	V _{GS} =10V, I _D = 6A		28	40	m ohm
		V _{GS} =4.5V, I _D = 5.2A		40	50	m ohm
On-State Drain Current	I _{D(ON)}	V _{DS} = 5V, V _{GS} = 10V	15			A
Forward Transconductance	g _{FS}	V _{DS} = 10V, I _D =6.0A	6			S
DYNAMIC CHARACTERISTICS^c						
Input Capacitance	C _{ISS}	V _{DS} =8V, V _{GS} = 0V f=1.0MHz		510		pF
Output Capacitance	C _{OSS}			155		pF
Reverse Transfer Capacitance	C _{RSS}			127		pF
SWITCHING CHARACTERISTICS^c						
Turn-On Delay Time	t _{D(ON)}	V _{DD} = 10V, I _D = 1A, V _{GEN} = 4.5V, R _L = 10 ohm R _{GEN} = 6 ohm		15.6		ns
Rise Time	t _r			9.7		ns
Turn-Off Delay Time	t _{D(OFF)}			26.3		ns
Fall Time	t _f			26.9		ns
Total Gate Charge	Q _g	V _{DS} =10V, I _D = 6A, V _{GS} =4.5V		9.3		nC
Gate-Source Charge	Q _{gs}			2.5		nC
Gate-Drain Charge	Q _{gd}			3.2		nC

STM4532

P-Channel ELECTRICAL CHARACTERISTICS (T_A = 25 °C unless otherwise noted)

Parameter	Symbol	Condition	Min	Typ ^c	Max	Unit
OFF CHARACTERISTICS						
Drain-Source Breakdown Voltage	BV _{DSS}	V _{GS} = 0V, I _D = -250uA	-30			V
Zero Gate Voltage Drain Current	I _{DSS}	V _{DS} = -24V, V _{GS} = 0V			-1	uA
Gate-Body Leakage	I _{GSS}	V _{GS} = ± 20V, V _{DS} = 0V			±100	nA
ON CHARACTERISTICS^b						
Gate Threshold Voltage	V _{GS(th)}	V _{DS} = V _{GS} , I _D = -250uA	-1	-1.5	-2.5	V
Drain-Source On-State Resistance	R _{DS(ON)}	V _{GS} = -10V, I _D = -4.9A		45	55	m ohm
		V _{GS} = -4.5V, I _D = -3.6A		75	85	m ohm
On-State Drain Current	I _{D(ON)}	V _{DS} = -5V, V _{GS} = -10V	-12			A
Forward Transconductance	g _{FS}	V _{DS} = -15V, I _D = - 4.9A	4			S
DYNAMIC CHARACTERISTICS^c						
Input Capacitance	C _{ISS}	V _{DS} = -15V, V _{GS} = 0V f = 1.0MHz		393		pF
Output Capacitance	C _{OSS}			116		pF
Reverse Transfer Capacitance	C _{RSS}			45		pF
SWITCHING CHARACTERISTICS^c						
Turn-On Delay Time	t _{D(ON)}	V _D = -15V, R _L = 15 ohm I _D = -1A, V _{GEN} = -10V, R _{GEN} = 6 ohm		13		ns
Rise Time	t _r			4.7		ns
Turn-Off Delay Time	t _{D(OFF)}			47.1		ns
Fall Time	t _f			17		ns
Total Gate Charge	Q _g	V _{DS} = -15V, I _D = -4.9A, V _{GS} = -10V		15.6		nC
		V _{DS} = -15V, I _D = -4.9A, V _{GS} = -4.5V		7.3		nC
Gate-Source Charge	Q _{gs}	V _{DS} = -15V, I _D = - 4.9A, V _{GS} = -10V		2.4		nC
Gate-Drain Charge	Q _{gd}			3.3		nC

STM4532

ELECTRICAL CHARACTERISTICS ($T_A=25^{\circ}\text{C}$ unless otherwise noted)

Parameter	Symbol	Condition	Min	Typ ^c	Max	Unit	
DRAIN-SOURCE DIODE CHARACTERISTICS^b							
Diode Forward Voltage	V_{SD}	$V_{GS} = 0\text{V}, I_S = 1.7\text{A}$	N-Ch		0.77	1.2	V
		$V_{GS} = 0\text{V}, I_S = -1.7\text{A}$	P-Ch		-0.82	-1.2	

Notes

- a. Surface Mounted on FR4 Board, $t \leq 10\text{sec}$.
- b. Pulse Test: Pulse Width $\leq 300\mu\text{s}$, Duty Cycle $\leq 2\%$.
- c. Guaranteed by design, not subject to production testing.

N-Channel

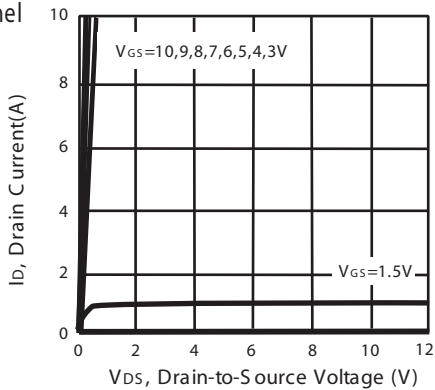

Figure 1. Output Characteristics

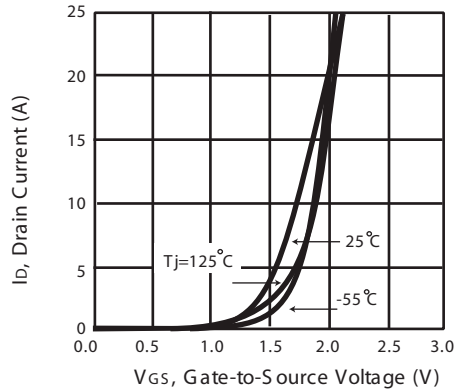

Figure 2. Transfer Characteristics

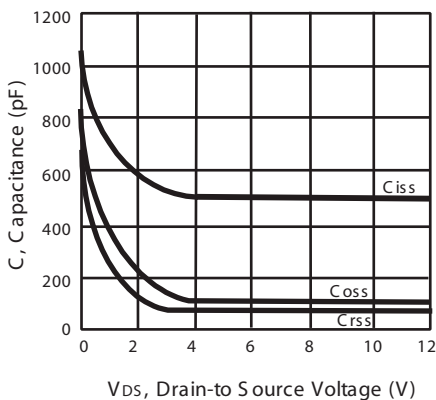

Figure 3. Capacitance

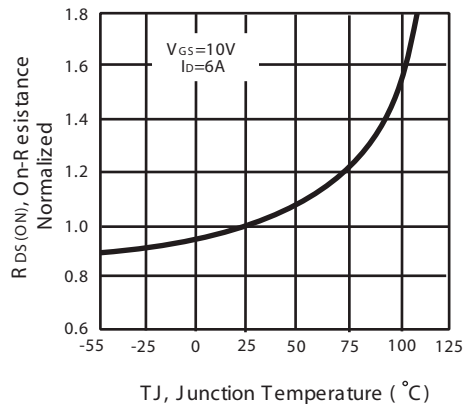

Figure 4. On-Resistance Variation with Drain Current and Temperature

STM4532

N-Channel

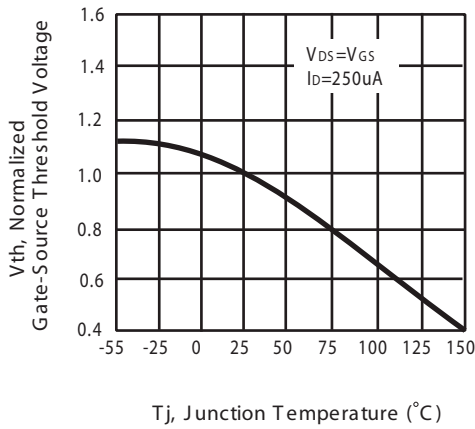

Figure 5. Gate Threshold Variation with Temperature

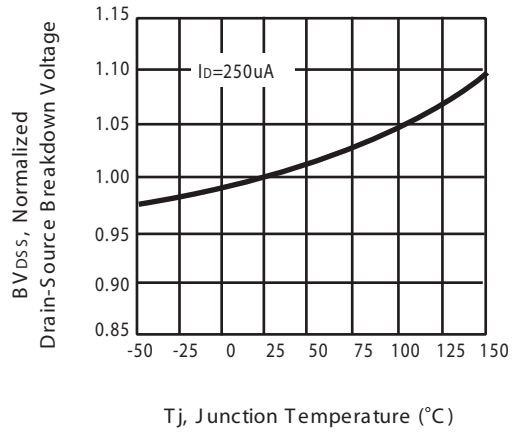

Figure 6. Breakdown Voltage Variation with Temperature

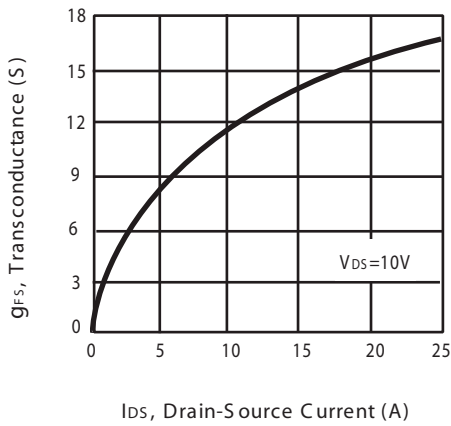

Figure 7. Transconductance Variation with Drain Current

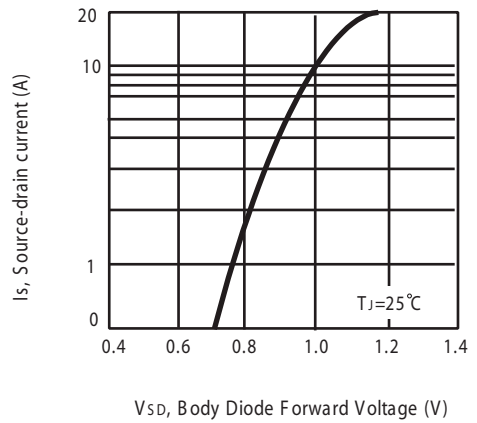

Figure 8. Body Diode Forward Voltage Variation with Source Current

STM4532

P-Channel

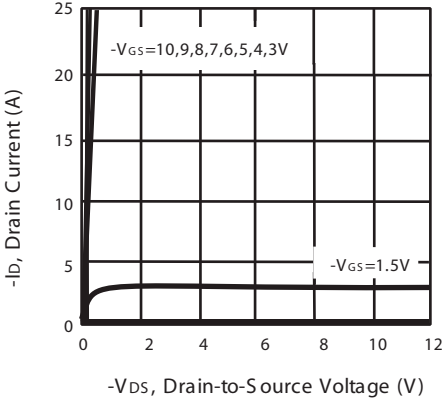

Figure 1. Output Characteristics

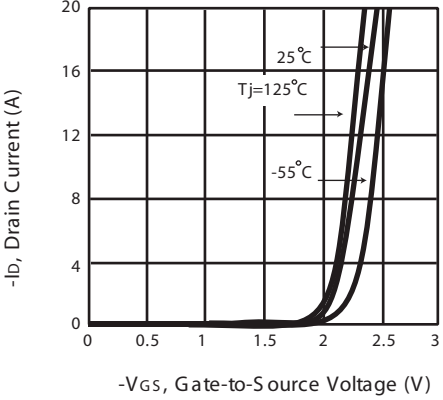

Figure 2. Transfer Characteristics

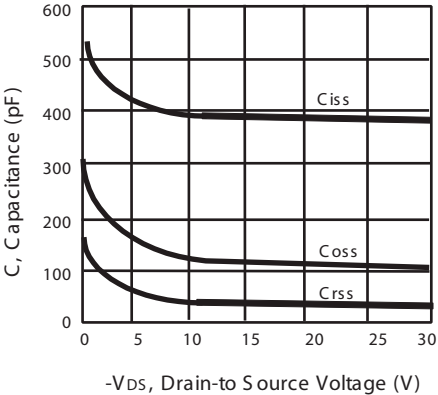

Figure 3. Capacitance

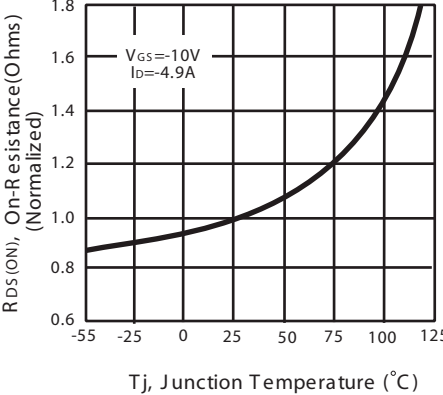
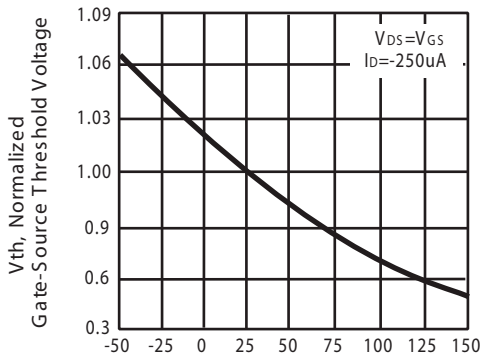

Figure 4. On-Resistance Variation with Temperature

STM4532

P-Channel



Tj, Junction Temperature (°C)

Figure 5. Gate Threshold Variation with Temperature

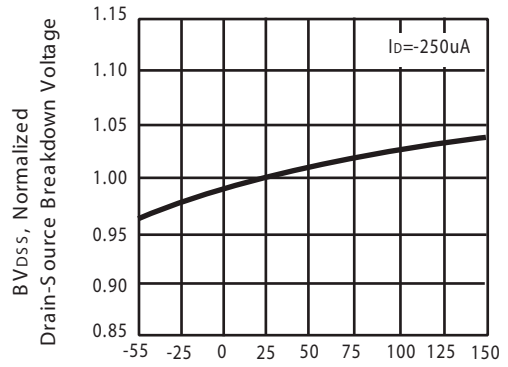

Tj, Junction Temperature (C)

Figure 6. Breakdown Voltage Variation with Temperature

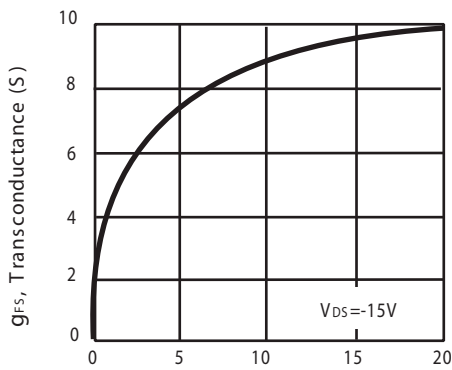

-Ids, Drain-Source Current (A)

Figure 7. Transconductance Variation with Drain Current

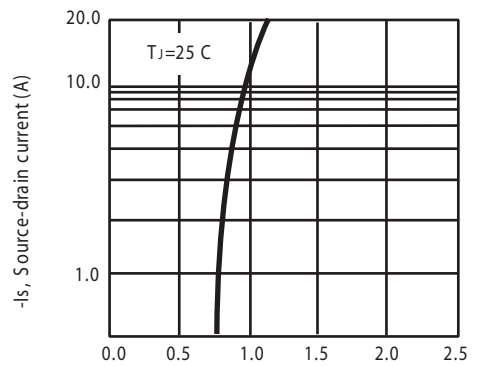

-VSD, Body Diode Forward Voltage (V)

Figure 8. Body Diode Forward Voltage Variation with Source Current

STM4532

N-Channel

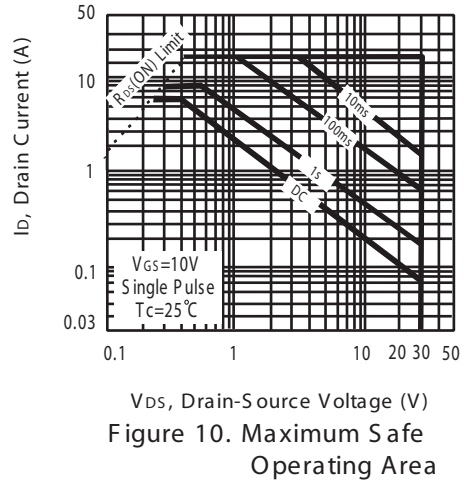
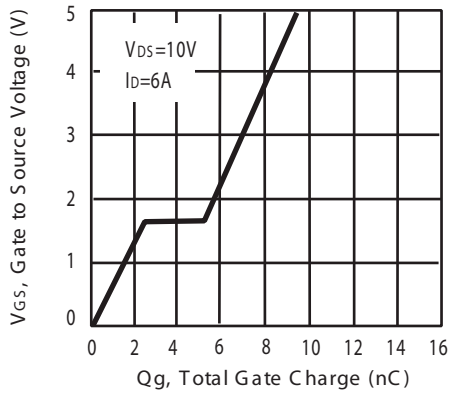

P-Channel

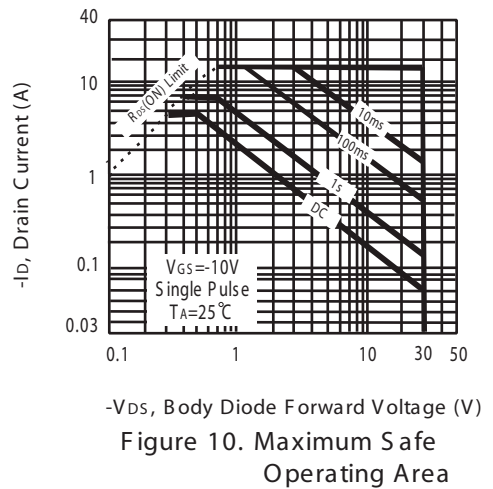
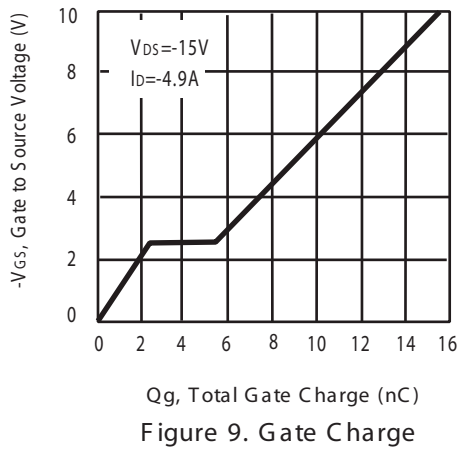

STM4532

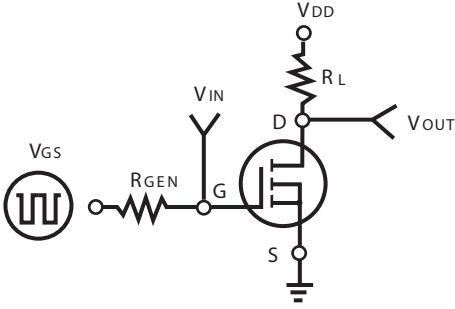

Figure 11. Switching Test Circuit

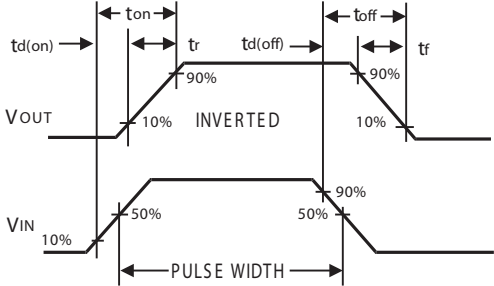

Figure 12. Switching Waveforms

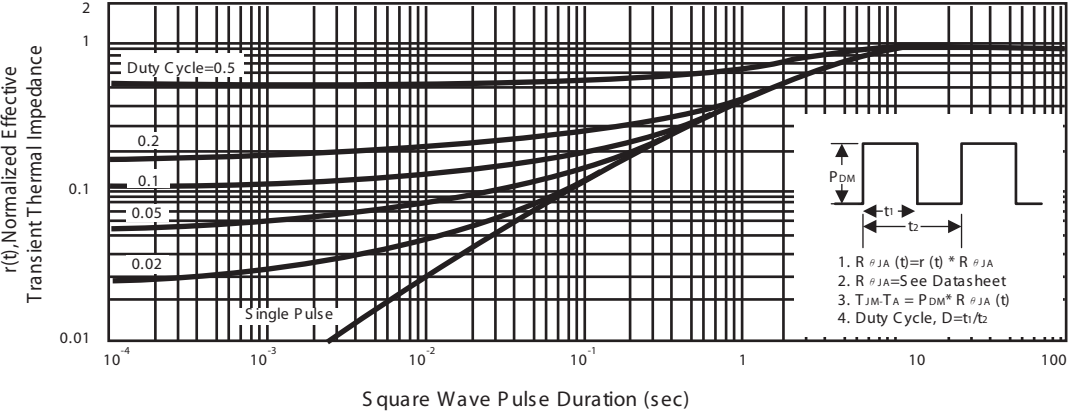
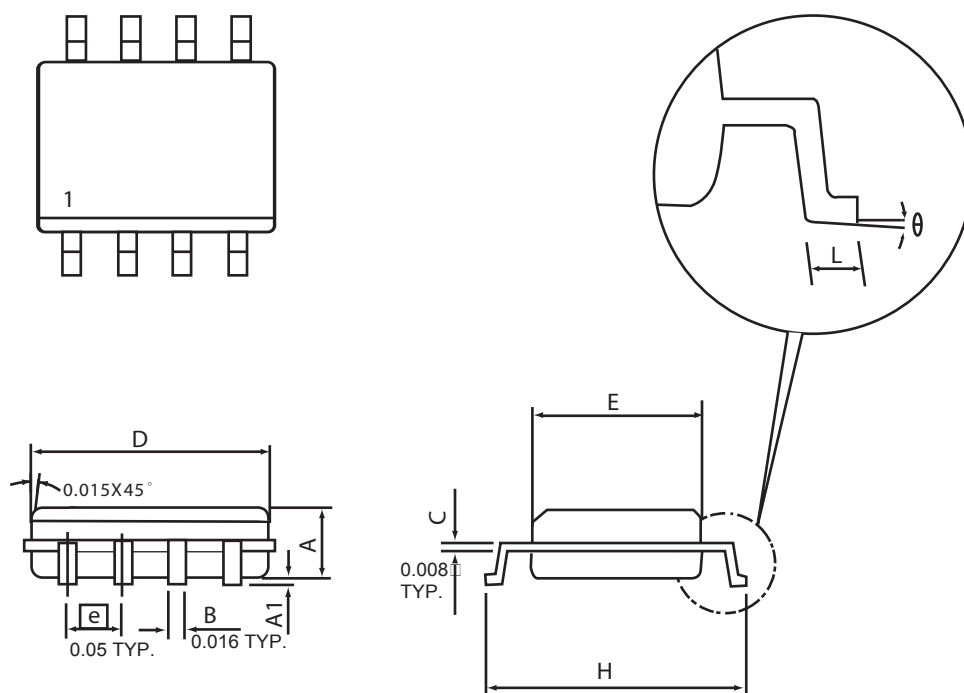

Figure 13. Normalized Thermal Transient Impedance Curve

STM4532

PACKAGE OUTLINE DIMENSIONS

SO-8



SYMBOLS	MILLIMETERS		INCHES	
	MIN	MAX	MIN	MAX
A	1.35	1.75	0.053	0.069
A1	0.10	0.25	0.004	0.010
D	4.80	4.98	0.189	0.196
E	3.81	3.99	0.150	0.157
H	5.79	6.20	0.228	0.244
L	0.41	1.27	0.016	0.050
θ	0°	8°	0°	8°

STM4532

SO-8 Tape and Reel Data

SO-8 Carrier Tape

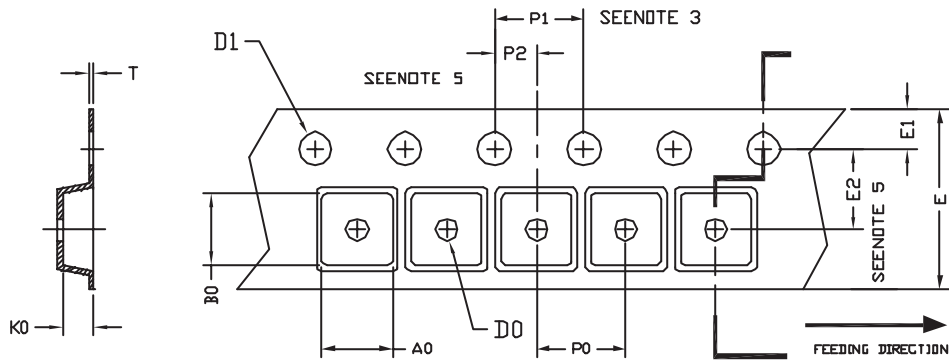

unit:mm

PACKAGE	A0	B0	K0	D0	D1	E	E1	E2	P0	P1	P2	T
SOP 8N 150mil	6.40	5.20	2.10	$\phi 1.5$ (MIN)	$\phi 1.5 \square$ $+ 0.1 \square$ $- 0.0$	12.0 ± 0.3	1.75	$5.5 \square$ ± 0.05	8.0	4.0	$2.0 \square$ ± 0.05	$0.3 \square$ ± 0.05

SO-8 Reel

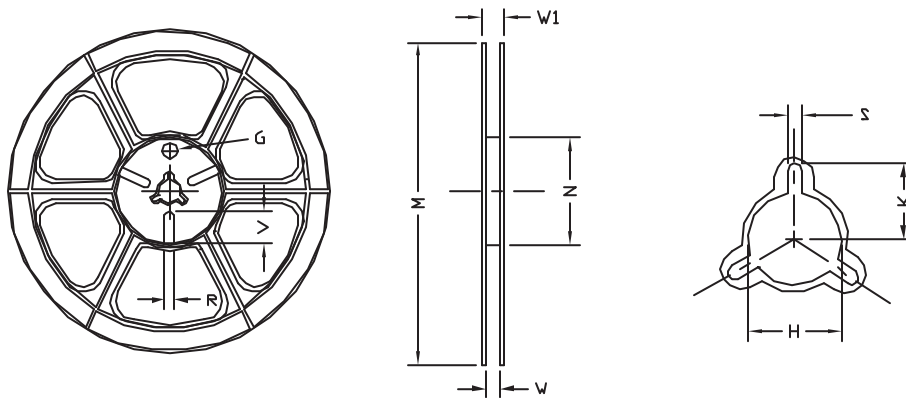

UNIT:mm

TAPE SIZE	REEL SIZE	M	N	W	W1	H	K	S	G	R	V
12 mm	$\phi 330$	330 ± 1	62 ± 1.5	$12.4 \square$ $+ 0.2$	$16.8 \square$ $- 0.4$	$\phi 12.75$ $+ 0.15$	---	$2.0 \square$ ± 0.15	---	---	---